



AHI Supply, Inc.



CAST STONE CATALOG



Dear Industry Professional,

Thank you for requesting our Cast Stone Catalog. AHI Supply, Inc. is committed to manufacturing quality architectural cast stone products at an affordable price with a focus on *customer satisfaction and service*. Since 1988, AHI has produced a large variety of cast stone products for projects throughout Texas.

- ***City Administrative Buildings***
- ***Community Centers***
- ***Museums, Churches, Hospitals***
- ***Schools, Universities, Historical Landmarks, Monuments***
- ***And hundreds of Residential Homes have been enhanced with cast stone by AHI Supply, Inc.***

Your designs are always welcome in our custom shop and our design department is always ready to assist you with your ideas.

Enclosed are over 30 pages of illustrations and specifications available for your review. Should you require an original CADD drawing on floppy disk, please contact us at our nearest location listed below or get in touch with us via our website at www.ahi-supply.com.

We look forward to working with you!

Sincerely,
AHI Supply, Inc.

AHI's Alvin, Texas Facility - Serving the Houston Area
Office (281)482-8292, (800)873-5794, Fax (281)331-9813

AHI's Buda, Texas Facility - Serving the Austin Area
Office (512)312-0879, (800)499-0984, Fax (512)295-3277

AHI's Roanoke, Texas Facility - Serving the Dallas/Fort Worth Area
Office (817)430-0228, (800)525-5382, Fax (817)430-4370

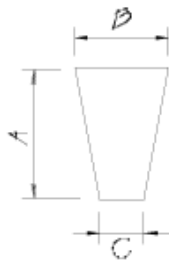

Flat Keystones

ITEM NUMBER	'A'	'B'	'C'	'D'
CSFKEY10D	10"	8"	5"	-
CSFKEY12D	12"	9-1/2"	6"	-
CSCFKEY12D *	12"	9-1/2"	6"	-

** THIS STONE IS CANTED, OR TILTED FORWARD*

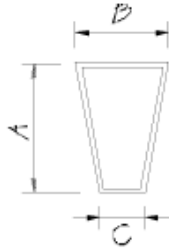

Beveled Keystones

ITEM NUMBER	'A'	'B'	'C'	'D'
CSBKEY6D	6"	2"	2"	-
CSBKEY8D	8"	4"	3"	-
CSBKEY9D	9"	6"	4"	-
CSCHKEY10D *	10"	8"	5"	-
CSBKEY12D	12"	10"	6"	-
CSBKEY15D	15"	12-1/2"	7-1/2"	-

** THIS STONE IS CHAMFERED, NOT BEVELED*

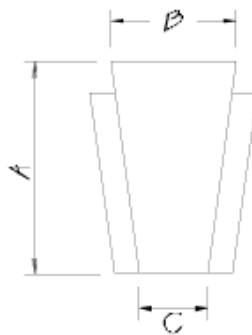

Batwing Keystones

ITEM NUMBER	'A'	'B'	'C'	'D'
CSBWKEY9	9"	6"	4"	-
CSBWKEY11	11"	9"	5-1/2"	-

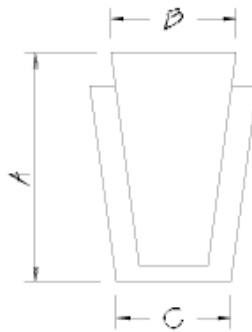

Batwing Keystones

ITEM NUMBER	'A'	'B'	'C'	'D'
CSBWKEY14D	14"	11"	6-3/4"	-
CSCBWKEY14D *	14"	10"	-	-

** THIS STONE IS CANTED, OR TILTED FORWARD*

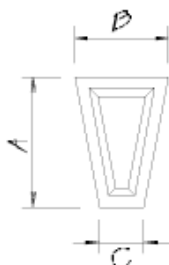

Recessed Keystones

ITEM NUMBER	'A'	'B'	'C'	'D'
CSRKEY10	10"	8"	4"	-
CSRKEY12	12"	9"	5"	-

FORM NO. 00003

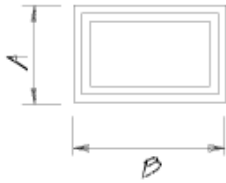

Small Address Stone

ITEM NUMBER	'A'	'B'	'C'	'D'
CSAS10D	9"	14"	-	-
CSAS102D *	9"	14"	-	-
CSAS10DBF	9"	14"	-	-
CSAS102DBF *	9"	14"	-	-

** USED FOR STUCCO-2" THICK*

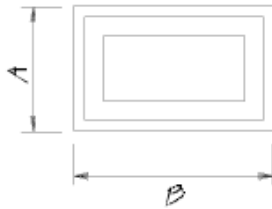

Large Address Stone

ITEM NUMBER	'A'	'B'	'C'	'D'
CSAS20D	11.5"	18.5"	-	-
CSAS202D *	11.5"	18.5"	-	-
CSAS20DBF	11.5"	18.5"	-	-
CSAS202DBF *	11.5"	18.5"	-	-

** USED FOR STUCCO-2" THICK*

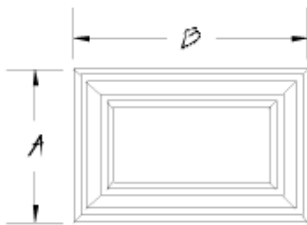

Stepped Address Stone

ITEM NUMBER	'A'	'B'	'C'	'D'
CSASSD	11.75"	18"	-	-
CSASSDBF	11.75"	18"	-	-

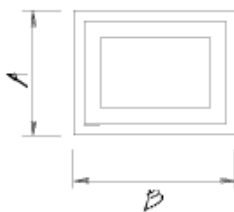

Block Address Stone

ITEM NUMBER	'A'	'B'	'C'	'D'
CSASSTD	11.5"	15"	-	-
CSASSTDBF	11.5"	15"	-	-

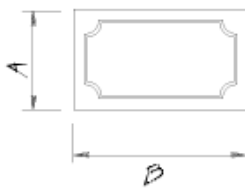

Scalloped Address Stone

ITEM NUMBER	'A'	'B'	'C'	'D'
CSAS30D	9.25"	16"	-	-
CSAS30DBF	9.25"	16"	-	-

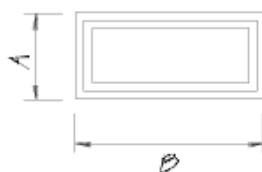

Narrow Address Stone

ITEM NUMBER	'A'	'B'	'C'	'D'
CSAS15D	8"	17.5"	-	-
CSAS15DBF	8"	17.5"	-	-

FORM NO. 00004

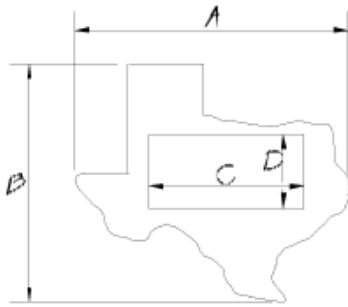

Texas Address Stone

ITEM NUMBER	"A"	"B"	"C"	"D"
CSASTXD	14-3/4"	14-1/2"	9-3/4"	5"
CSASTXDBF	14-3/4"	14-1/2"	9-3/4"	5"

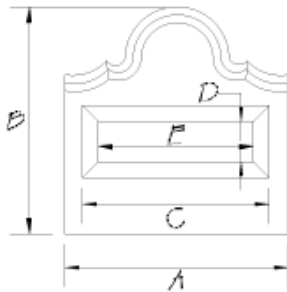

Mission Address Stone

ITEM NUMBER	"A"	"B"	"C"	"D"	"E"
CSASMD	14"	14-1/8"	12"	3"	10-1/2"
CSASMDBF	14"	14-1/8"	12"	3"	10-1/2"

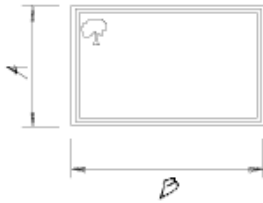

Oak Tree Address Stone

ITEM NUMBER	"A"	"B"	"C"	"D"
CSASOAKD	11.5"	18.5"	-	-
CSASOAKDBF	11.5"	18.5"	-	-

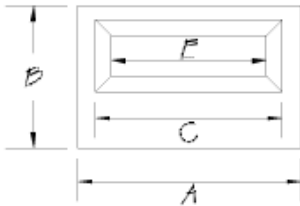

Offset Address Stone

ITEM NUMBER	"A"	"B"	"C"	"D"	"E"
CSASOD	14"	11"	12"	-	10-1/2"
CSASODBF	14"	11"	12"	-	10-1/2"

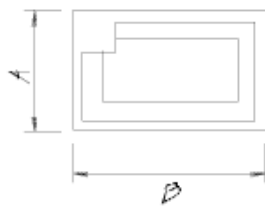

Monogram Address Stone

ITEM NUMBER	"A"	"B"	"C"	"D"
CSASMGD	11.5"	18.5"	-	-
CSASMGBF	11.5"	18.5"	-	-

FORM NO. 00005

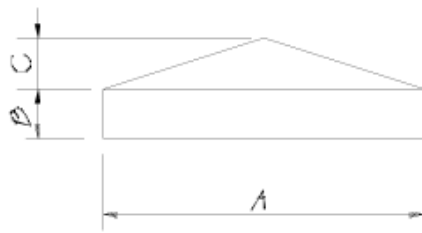

Pyramid Column Caps-Typical Profile

ITEM NUMBER	"A"	"B"	"C"	"D"
CSPT1222	12"	2"	2"	—
CSPT1422	14"	2"	2"	—
CSPT1622	16"	2"	2"	—
CSPT1822	18"	2"	2"	—
CSPT2022	20"	2"	2"	—
CSPT2222	22"	2"	2"	—
CSPT2433	24"	3"	3"	—
CSPT2633	26"	3"	3"	—
CSPT2833	28"	3"	3"	—
CSPT3033	30"	3"	3"	—

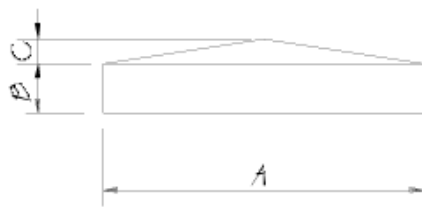

Pyramid Column Caps-Short Profile

ITEM NUMBER	"A"	"B"	"C"	"D"
CSPS1222	12"	2"	1"	—
CSPS1422	14"	2"	1"	—
CSPS1622	16"	2"	1"	—
CSPS1822	18"	2"	1"	—
CSPS2022	20"	2"	1"	—
CSPS2222	22"	2"	1"	—

Note: Use Typical Profile for 24" thru 30"

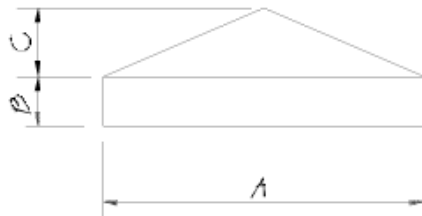

Pyramid Column Caps-Tall Profile

ITEM NUMBER	"A"	"B"	"C"	"D"
CSPTLL1224	12"	2"	4"	—
CSPTLL1424	14"	2"	4"	—
CSPTLL1624	16"	2"	4"	—
CSPTLL1824	18"	2"	4"	—
CSPTLL2024	20"	2"	4"	—
CSPTLL2224	22"	2"	4"	—
CSPTLL2436	24"	3"	6"	—
CSPTLL2636	26"	3"	6"	—
CSPTLL2836	28"	3"	6"	—
CSPTLL3036	30"	3"	6"	—

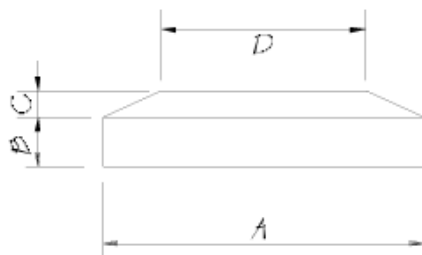

Flat Top Pyramid Caps

ITEM NUMBER	"A"	"B"	"C"	"D"
CSPF1222	12"	2"	2"	—
CSPF1422	14"	2"	2"	—
CSPF1622	16"	2"	2"	—
CSPF1822	18"	2"	2"	—
CSPF2022	20"	2"	2"	—
CSPF2222	22"	2"	2"	—
CSPF2433	24"	3"	3"	—
CSPF2633	26"	3"	3"	—
CSPF2833	28"	3"	3"	—
CSPF3033	30"	3"	3"	—

FORM NO. 00006

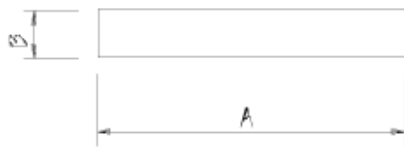

Flat Column Caps

ITEM NUMBER	"A"	"B"	"C"	"D"
CSCF123	12"	3"	—	—
CSCF143	14"	3"	—	—
CSCF163	16"	3"	—	—
CSCF183	18"	3"	—	—
CSCF203	20"	3"	—	—
CSCF223	22"	3"	—	—
CSCF244	24"	4"	—	—
CSCF264	26"	4"	—	—
CSCF284	28"	4"	—	—
CSCF304	30"	4"	—	—

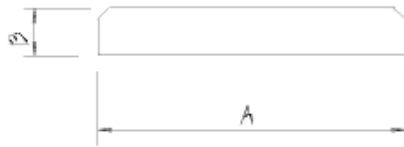

Chamfered Column Caps

ITEM NUMBER	"A"	"B"	"C"	"D"
CSCC123	12"	3"	—	—
CSCC143	14"	3"	—	—
CSCC163	16"	3"	—	—
CSCC183	18"	3"	—	—
CSCC203	20"	3"	—	—
CSCC223	22"	3"	—	—
CSCC244	24"	4"	—	—
CSCC264	26"	4"	—	—
CSCC284	28"	4"	—	—
CSCC304	30"	4"	—	—

FORM NO. 00007

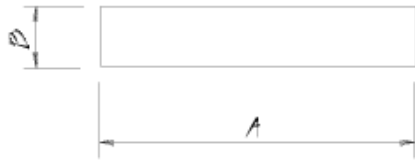

NOTE: "D" - LENGTH

Flat Wall Caps

ITEM NUMBER	"A"	"B"	"C"	"D"
CSF2104	10"	4"	-	48"
CSF284	8"	4"	-	48"

FORM NO. 00009

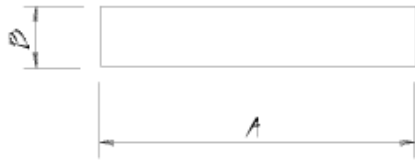

NOTE: "D" - LENGTH

Flat Wall Caps

ITEM NUMBER	"A"	"B"	"C"	"D"
CSF2104	10"	4"	-	48"
CSF284	8"	4"	-	48"

FORM NO. 00009

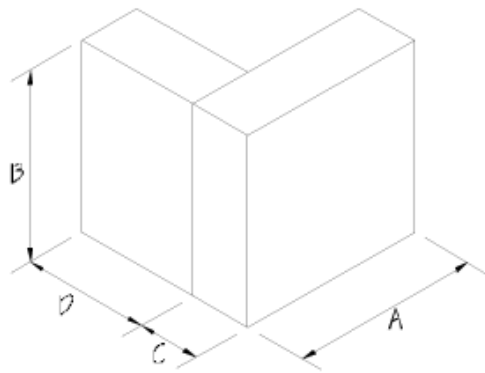

Quoins

ITEM NUMBER	"A"	"B"	"C"	"D"
12"x12"x12"	12"	12"	4"	8"
16"x16"x12"	16"	12"	4"	12"
22"x22"x12"	22"	12"	4"	16"

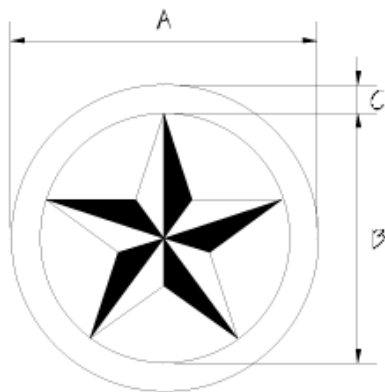

Star

ITEM NUMBER	"A"	"B"	"C"	"D"
CSASS	32"	26"	3"	-
CSASS	16"	13-1/2"	1-1/4"	-

FORM NO. 00010

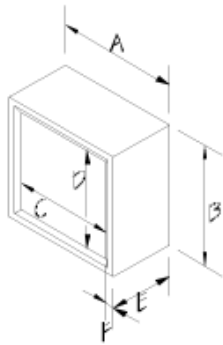

Recessed Plinth

ITEM NUMBER	'A'	'B'	'C'	'D'	'E'	'F'
8"x8"	8"	8"	6-1/2"	6-1/2"	4-1/2"	3-1/4"
8"x12"	8"	12"	6-1/2"	10-1/2"	4-1/4"	3-1/4"
9-3/4"x9-3/4"	9-3/4"	9-3/4"	8-1/4"	8-1/4"	7-3/4"	6-3/4"
12"x12"	12"	12"	10-1/2"	10-1/2"	5-3/4"	4-3/4"

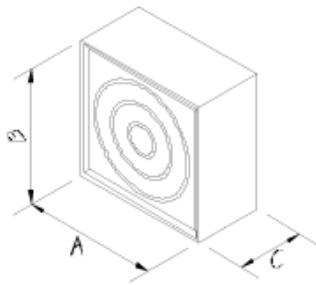

Rosette Plinth

ITEM NUMBER	'A'	'B'	'C'	'D'
6"x6"	6"	6"	3"	-

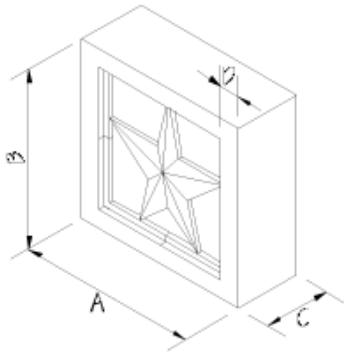

Star Plinth

ITEM NUMBER	'A'	'B'	'C'	'D'
8"x8"	8"	8"	3"	3/4"

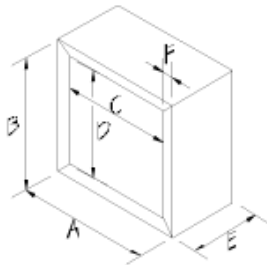

Chamfered Plinth

ITEM NUMBER	'A'	'B'	'C'	'D'	'E'	'F'
8"x8"	8"	8"	6-1/2"	6-1/2"	4-1/4"	3-1/4"
8"x12"	8"	12"	6-1/2"	10-1/2"	4-1/4"	3-1/4"
9-3/4"x9-3/4"	9-3/4"	9-3/4"	8-1/4"	8-1/4"	7-3/4"	6-3/4"
12"x12"	12"	12"	10-1/2"	10-1/2"	5-3/4"	4-3/4"

FORM NO. 0001



Pineapple Finial

ITEM NUMBER	'A'	'B'	'C'	'D'	'E'
CSASPF	12"	-	-	-	-



1 1/2 Ball Finial (Round Base)

ITEM NUMBER	'A'	'B'	'C'	'D'	'E'
CSASBF	12"	-	-	-	-

FORM NO. 00612

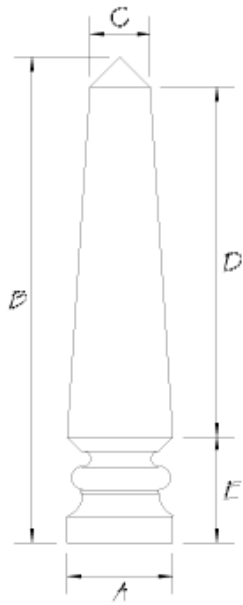

Spire Finial

ITEM NUMBER	'A'	'B'	'C'	'D'	'E'
CSASSF	7"	23"	4"	14"	7"

FORM NO. 00013

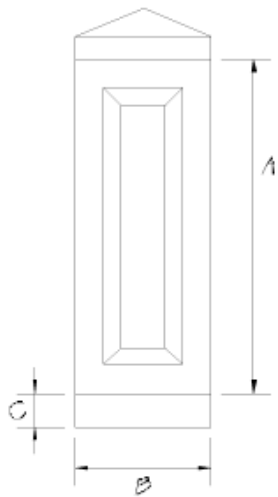

Newel Post

ITEM NUMBER	'A'	'B'	'C'	'D'	'E'
CSASNP	37"	24"	5"	-	-

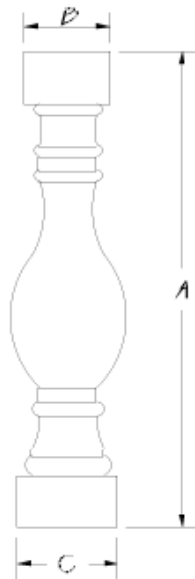

Balustrade #1

ITEM NUMBER	'A'	'B'	'C'	'D'
CSBAL1	33-3/4"	6"	7"	-

FORM NO. 00014

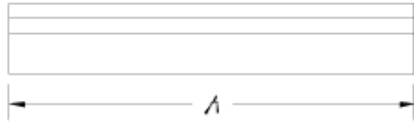

Bases

ITEM NUMBER	'A'	'B'	'C'	'D'
CSBASE	54"	11-1/4"	4-3/4"	-

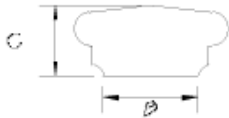
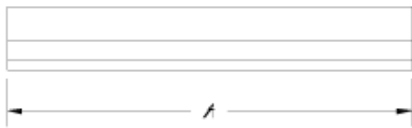
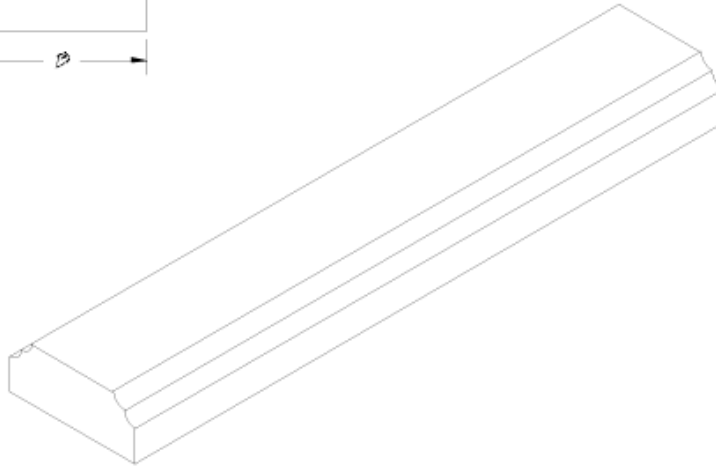

Hand Rail

ITEM NUMBER	'A'	'B'	'C'	'D'
CSBAL2	54"	4"	9"	-

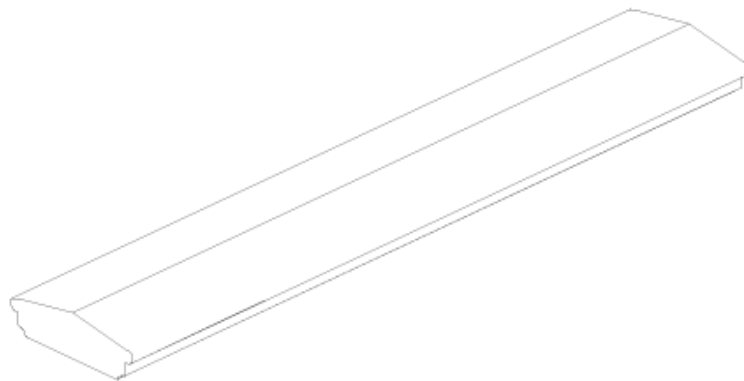

FORM NO. 00015

10 Column

ITEM NUMBER	"A"	"B"	"C"	"D"
CSCOL10	Varies	13"	10-3/4"	-

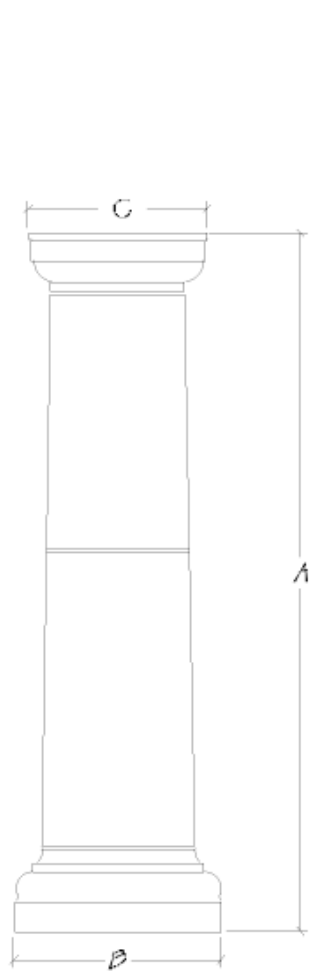

Note: Mortar Joints 2/8"

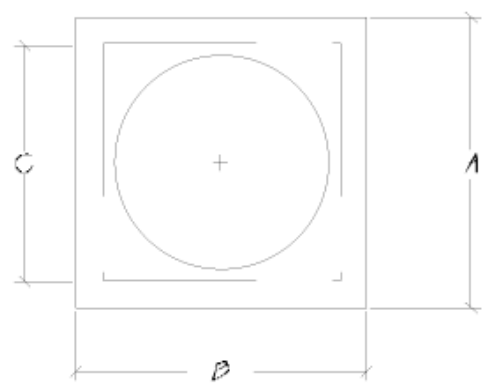
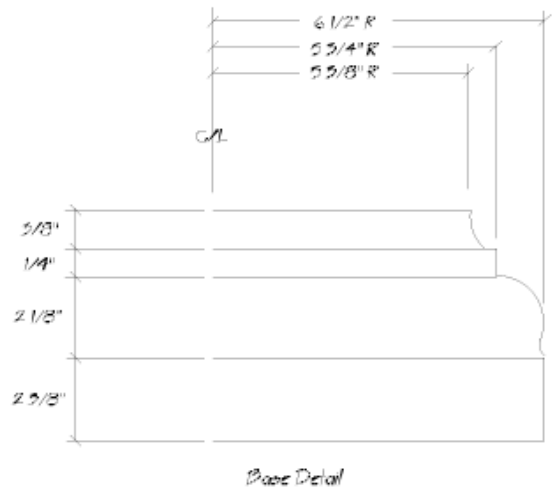
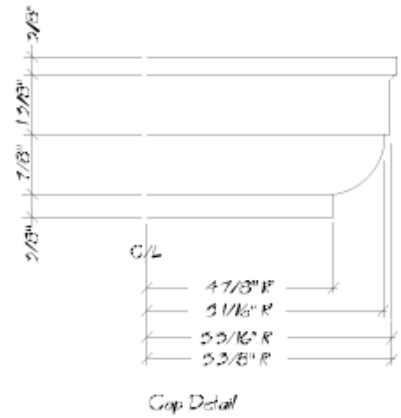

FORM NO. 00016

12" Column

ITEM NUMBER	'A'	'B'	'C'	'D'
CSCOL12	Varies	16-1/2"	-	-

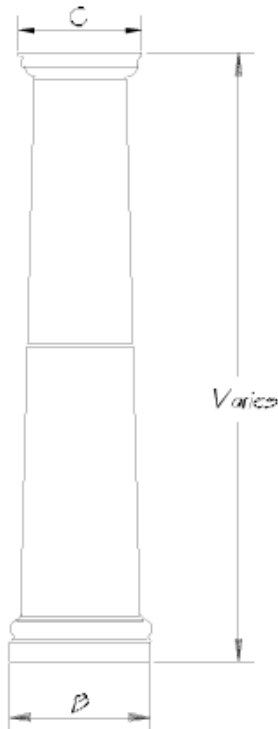

Note: Marked Joints 3/8"

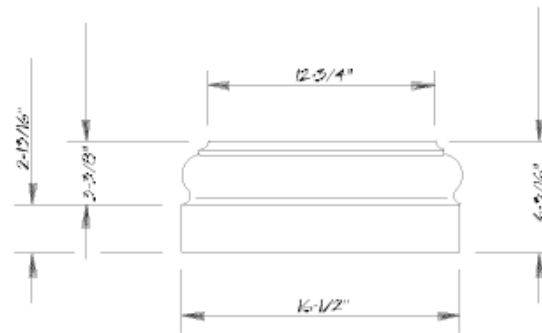
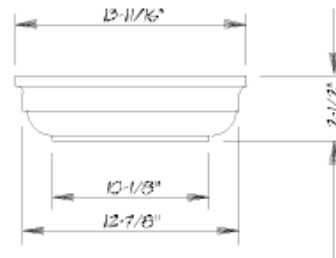

FORM NO. 00017

16 Column

ITEM NUMBER	'A'	'B'	'C'	'D'
CSCOL 16	Varies	21-3/4"	19-1/16"	-

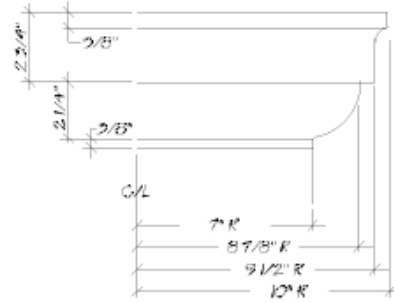
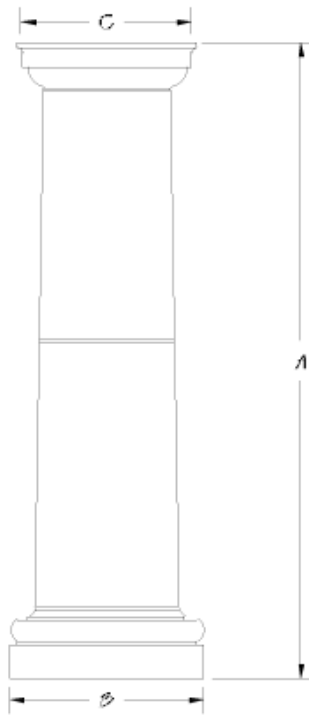

Cap Detail

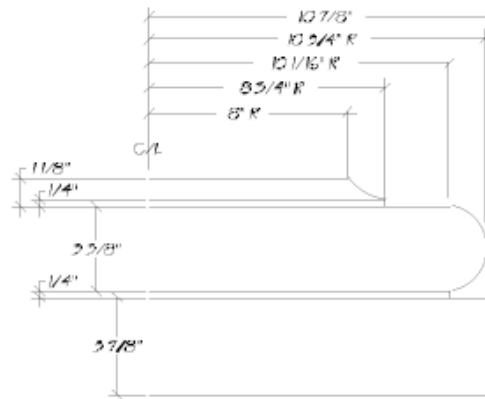

Base Detail

Note: Molar Joints 3/8"

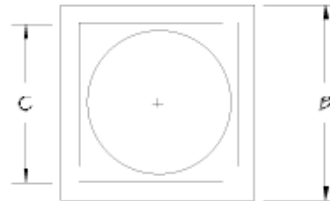

FORM NO. 00018

18 Column

ITEM NUMBER	'A'	'B'	'C'	'D'
CSCOL18	Varies	23-1/2"	19-1/16"	-

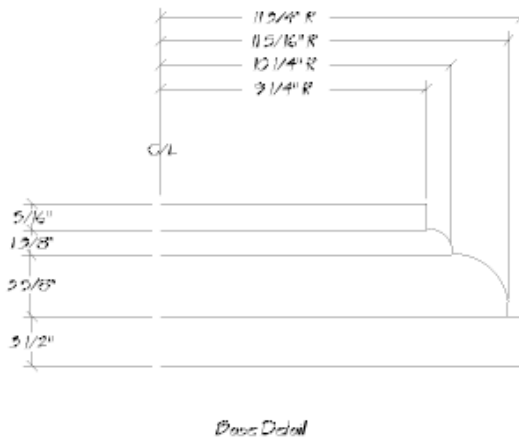
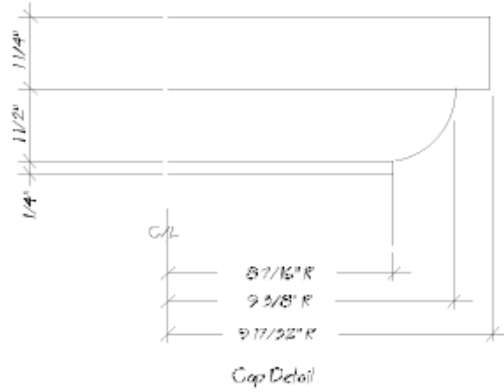
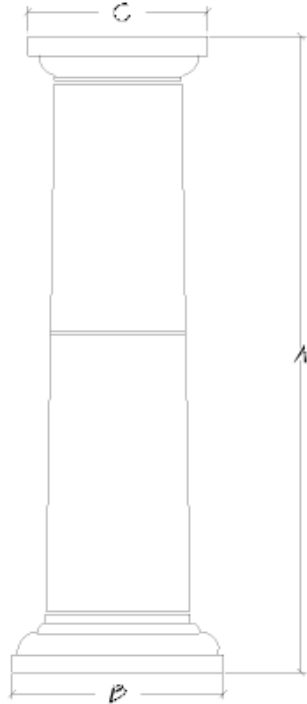

Note: Mortar Joints 5/8"

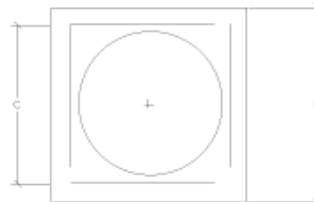

FORM NO. 00019

24 Column

ITEM NUMBER	'A'	'B'	'C'	'D'
CSC0L24	Varies	29-1/2"	25-3/4"	-

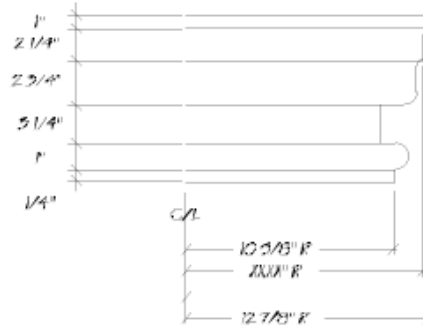
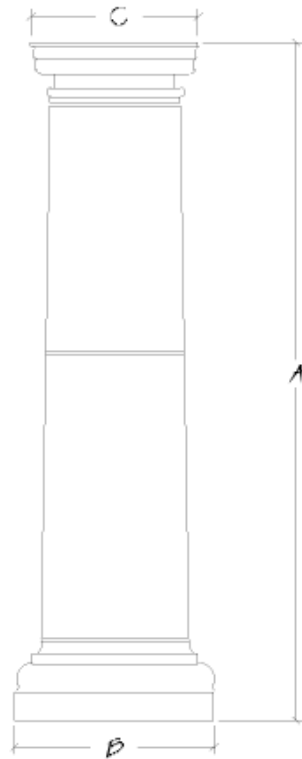

Cap Detail

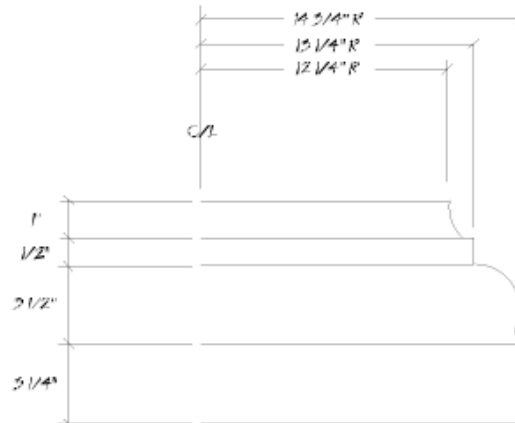

Base Detail

Note: Mortar Joints 3/8"

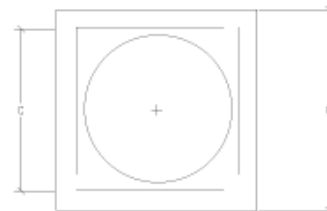

FORM NO. 00020

30 Waterford Column (Square)

ITEM NUMBER	'A'	'B'	'C'	'D'
GSWGOL30	Varies	30"	17"	18"

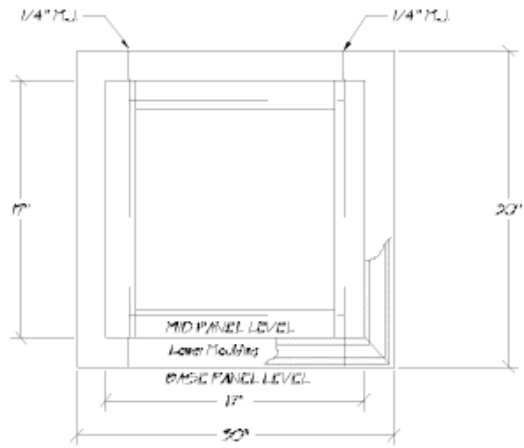
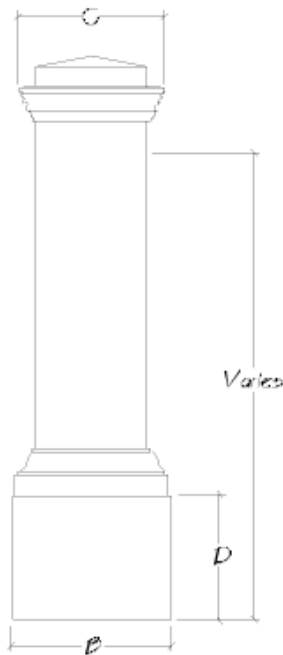

COLUMN CUTAWAY BELOW UPPER MOULDING

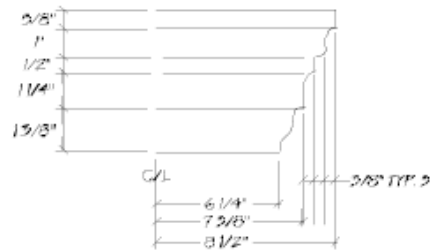

COLUMN CAP DETAIL

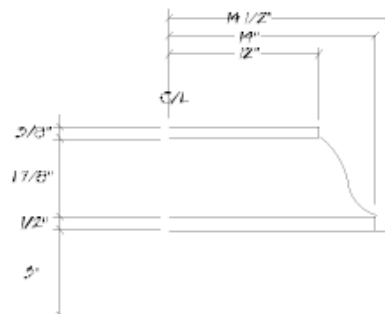

COLUMN BASE DETAIL

Note: Mortar Joints 3/8"

FORM NO. GCG22

Dusenbury (Fireplace)

ITEM NUMBER	"A"	"B"	"C"	"D"
CSFPDB	-	-	-	-



Edward 1 (Fireplace)

ITEM NUMBER	"A"	"B"	"C"	"D"
CSFPED1	-	-	-	-



FORM NO. 00025

Note - Virtually every molding profile we offer is available in lengths up to 36 inches.
 Also, every profile has been replicated in many different radii for arched applications such as window surrounds and entices.

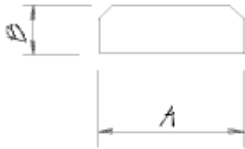

MLD-10 Molding

ITEM NUMBER	'A'	'B'	'C'	'D'
CSML1064	6"	4"	-	36"
CSML1084	8"	4"	-	36"

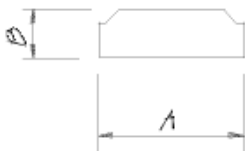

MLD-15 Molding

ITEM NUMBER	'A'	'B'	'C'	'D'
CSML1564	6"	4"	-	36"
CSML1584	8"	4"	-	36"

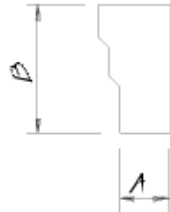

MLD-20 Molding

ITEM NUMBER	'A'	'B'	'C'	'D'
CSML2084	4"	8"	-	36"



MLD-30 Molding

ITEM NUMBER	'A'	'B'	'C'	'D'
CSML30735	3.5"	7"	-	36"

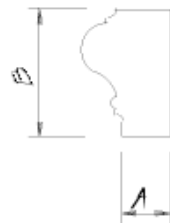

MLD-40 Molding

ITEM NUMBER	'A'	'B'	'C'	'D'
CSML4063	3"	6"	-	36"

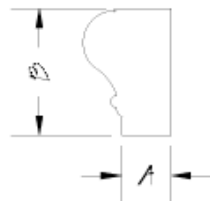

MLD-45 Molding

ITEM NUMBER	'A'	'B'	'C'	'D'
CSML4584	4"	8"	-	36"

FORM NO. 00025

Note - Virtually every molding profile we offer is available in lengths up to 36 inches.
 Also, every profile has been replicated in many different radii for arched applications such as window surrounds and entries.



MLD-50 Molding

ITEM NUMBER	"A"	"B"	"C"	"D"
CSML508475	4.75"	8"	-	36"



MLD-55 Molding

ITEM NUMBER	"A"	"B"	"C"	"D"
CSML5512475	4.75"	12"	-	36"

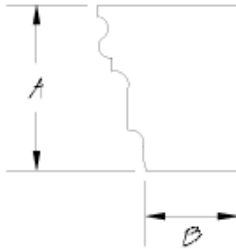

MLD-60 Molding

ITEM NUMBER	"A"	"B"	"C"	"D"
CSML60432	4-3/4"	3-3/4"	-	36"

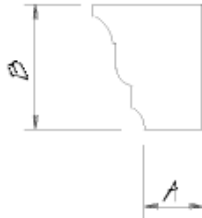

MLD-65 Molding

ITEM NUMBER	"A"	"B"	"C"	"D"
CSML6564	4"	6"	-	36"

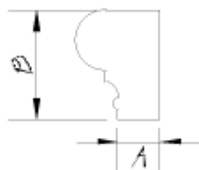

MLD-70 Molding

ITEM NUMBER	"A"	"B"	"C"	"D"
CSML7064	4"	6"	-	36"

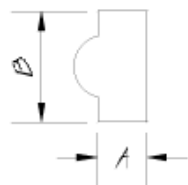

MLD-75 Molding

ITEM NUMBER	"A"	"B"	"C"	"D"
CSML7544	4"	4"	-	36"

FORM NO. 00026

Belaire Entry

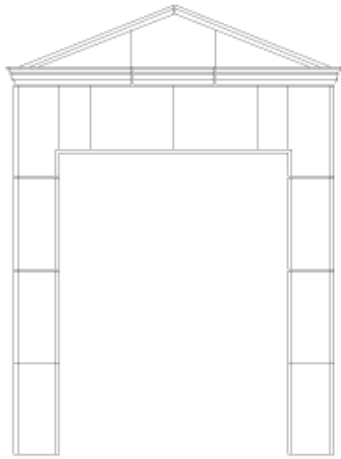

Bentwater Entry

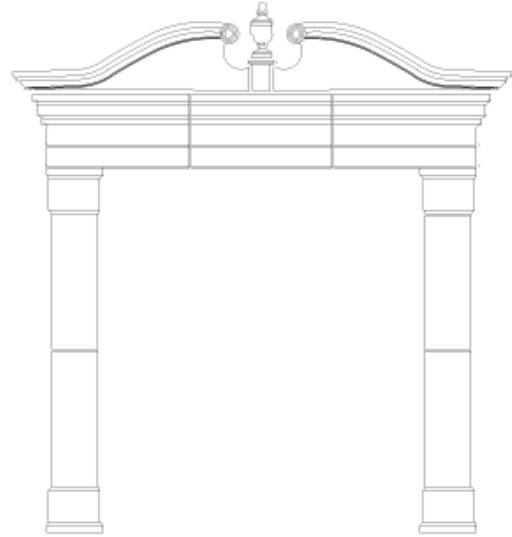

Inverness Entry

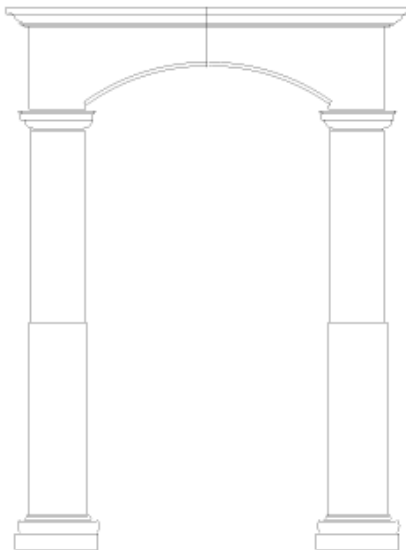

Inverness II Entry

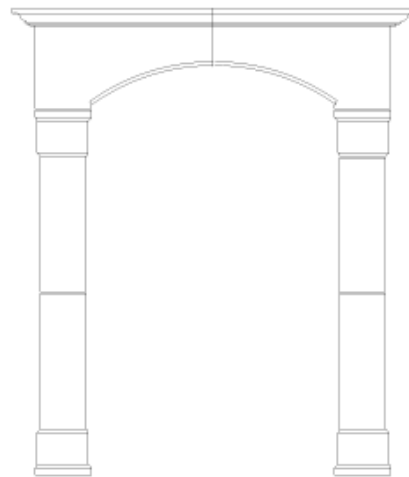

Note: Dimensions vary per application

FORM NO. 00027

Phillip House Entry

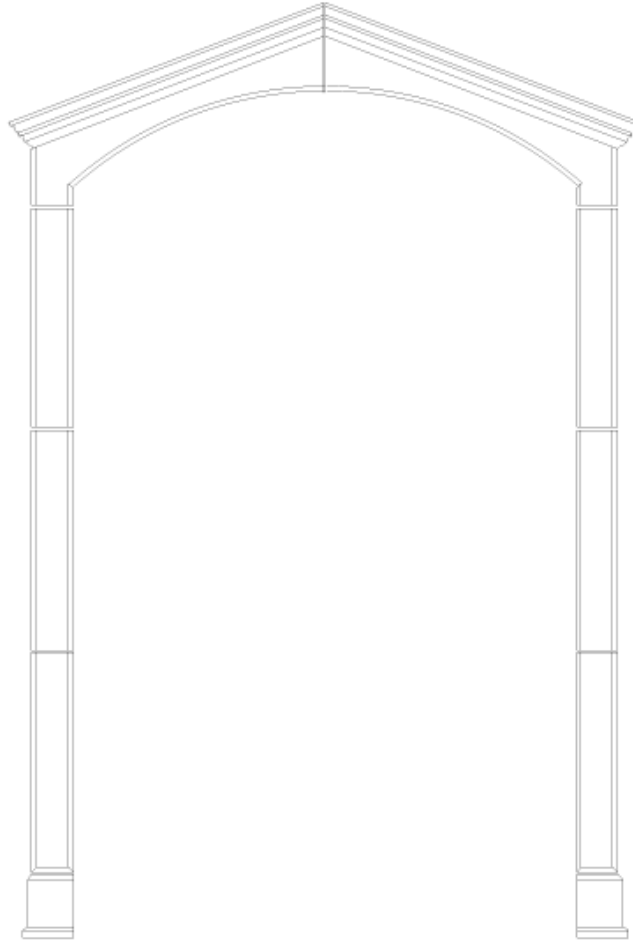

Note: Dimensions vary per application

FORM NO. 00051

Chamfered Sign Panel

ITEM NUMBER	"A"	"B"	"C"	"D"	"E"	"F"
GSCSP30	30"	15"	28-1/2"	13-1/2"	3-3/4"	3/4"
GSCSP78	78"	22"	76-1/2"	20-1/2"	2-1/4"	3/4"
GSCSP96	96"	30"	94-1/2"	28-1/2"	3-1/4"	3/4"

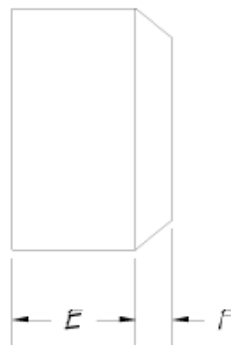
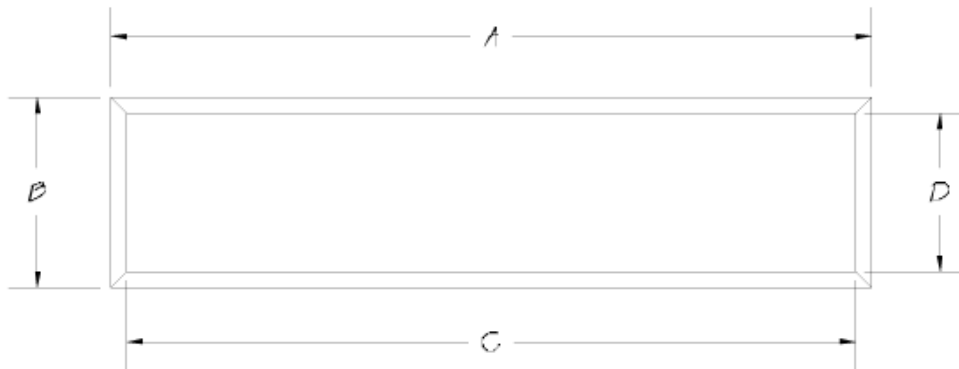

FORM NO. 00052

Flat Sign Panel

ITEM NUMBER	"A"	"B"	"C"	"D"	"E"	"F"
CSFSP57	57"	25-1/2"	3"	-	-	-
CSFSP72	72"	48"	4"	-	-	-
CSFSP78	78"	20"	4"	-	-	-



FORM NO. 00033

Recessed Sign Panel

ITEM NUMBER	'A'	'B'	'C'	'D'	'E'	'F'
CSRSP24	24"	15"	18-1/2"	9-1/2"	3-1/4"	3/4"
CSRSP27	27"	18"	21-1/2"	12-1/2"	3-1/4"	3/4"
CSRSP31	31"	13"	29"	11"	3-1/4"	3/4"
CSRSP60	60"	36"	44-1/2"	30-1/2"	3-1/4"	3/4"
CSRSP96S	96"	18"	91"	15"	3-1/4"	3/4"
CSRSP96M	96"	36"	90-1/2"	30-1/2"	3-1/4"	3/4"
CSRSP96L	96"	48"	90-1/2"	42-1/2"	3-1/4"	3/4"

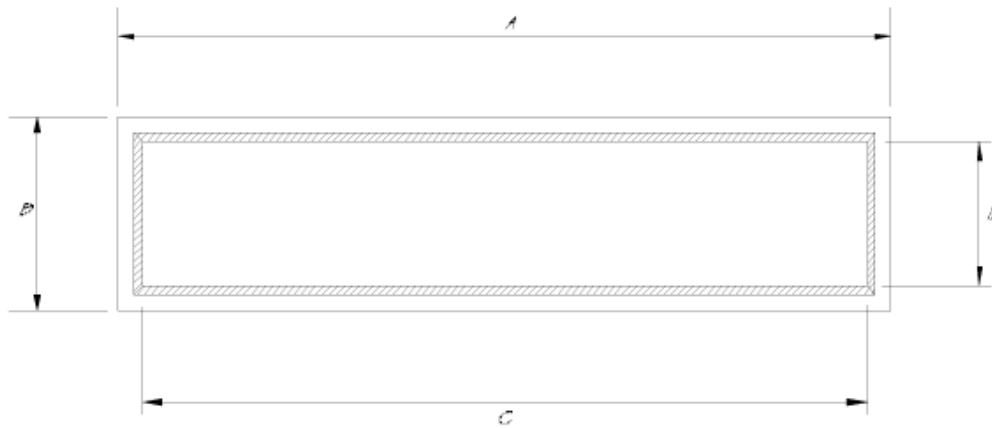

FORM NO. 00034

Standard Window Sill

ITEM NUMBER	'A'	'B'	'C'	'D'	'E'	'F'
CSSWS1018W	18"	6-3/4"	3-1/8"	4"	3"	1-7/8"
CSSWS1024W	24"	6-3/4"	3-1/8"	4"	3"	1-7/8"
CSSWS1036W	36"	6-3/4"	3-1/8"	4"	3"	1-7/8"
CSSWS1048W	48"	6-3/4"	3-1/8"	4"	3"	1-7/8"
CSSWS1060W	60"	6-3/4"	3-1/8"	4"	3"	1-7/8"
CSSWS1072W	72"	6-3/4"	3-1/8"	4"	3"	1-7/8"

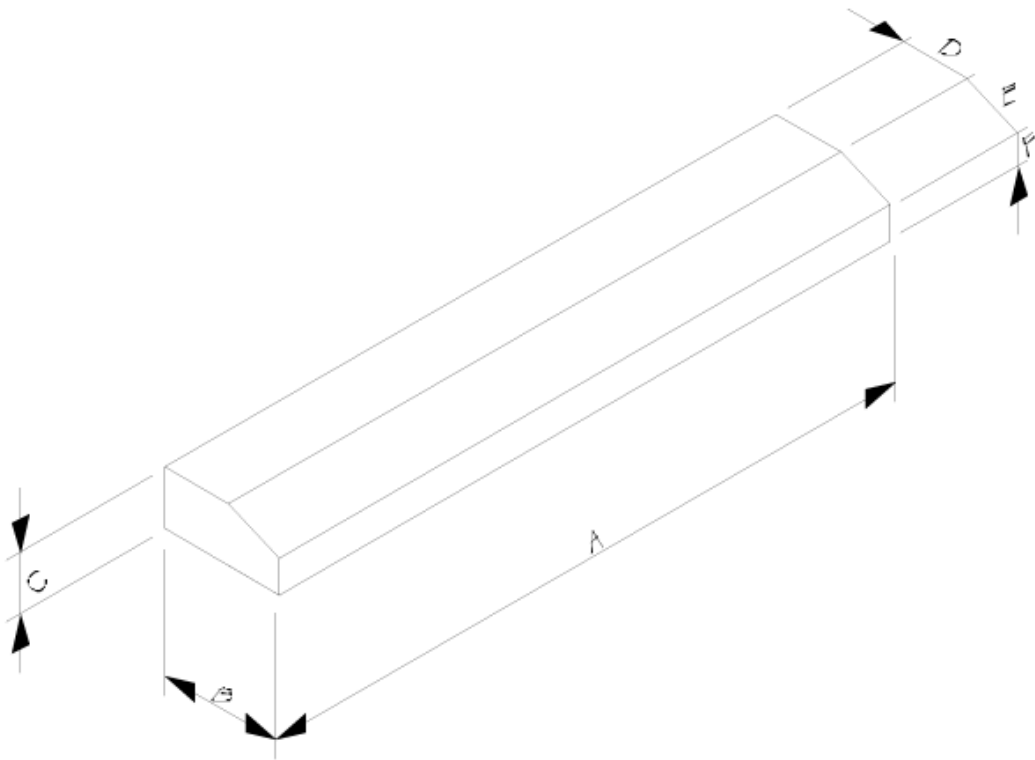
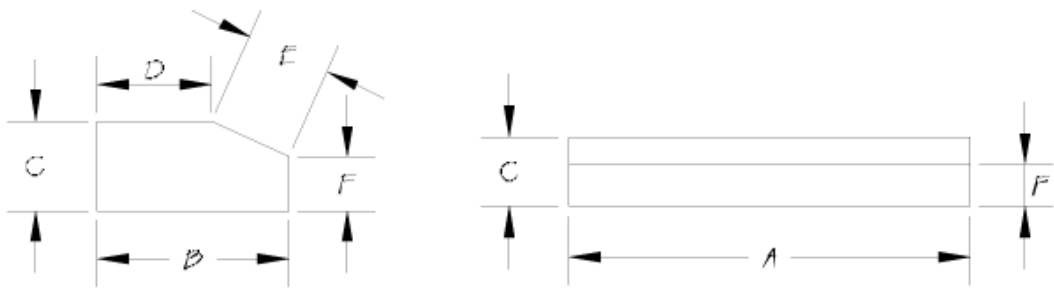

FORM NO. 00035

Fireplace I

ITEM NUMBER	'A'	'B'	'C'	'D'
CSF1	-	-	-	-



Note: All dimensions vary per application

Fireplace II

ITEM NUMBER	'A'	'B'	'C'	'D'
CSF2	-	-	-	-



Note: All dimensions vary per application

FORM NO. 00036

Window Sill

ITEM NUMBER	"A"	"B"	"C"	"D"	"E"	"F"
CSW55466	54"	6"	6"	-	-	-

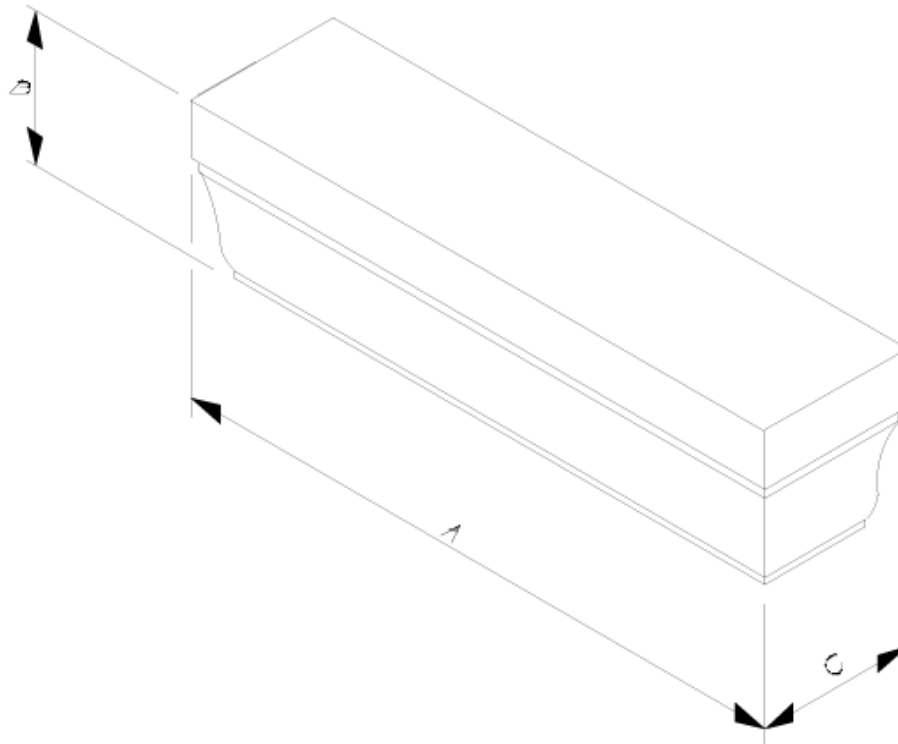

FORM NO. 00358